

## OPTOTRONIC Intelligent – DALI NFC

Compact constant current LED driver – Dimmable



### Areas of application

- Installation in emergency lighting systems according to IEC 61347-2-13, appendix J
- Suitable for use in luminaires with flexible current setting
- Suitable for indoor SELV installations
- Suitable for luminaires of protection classes I and II
- Suitable for downlights, spotlights and LED panels
- Installation via Cable Clamp Kit possible (depending on version of product)

### Product family benefits

- Versatile DALI window driver due to flexible output characteristic
- Locking and unlocking of luminaire/driver data
- Advanced luminaire/driver data (power, energy, operating hours...) for analytics
- DALI-2 certified incl. Parts 251, 252, 253
- Easy and fast output current setting via NFC
- Very high efficiency
- High-quality dimming of 1...100 % by amplitude dimming

### Versatile scope of application due to OSRAM DALI Technology:

- Suitable for emergency installations (acc. to EN 60598-2-22 and IEC 61347-2-13, appendix J) thanks to DC detection (0 Hz, pulsating DC), on/off switchable
- Feedback of power consumption and operating hours (Fit for SMART GRID)
- Suitable for buildings according to EPBD/BREEAM/LEED due to automatic Constant Lumen Output setting



## Product family datasheet

---

### Product family features

- Supply voltage: 220...240 V
- Line frequency: 0 Hz | 50 Hz | 60 Hz
- Line voltage: 198...264 V
- According to EN 61347-1, 61347-2-13, 62384
- RI suppression: to EN 55015/CISPR 15
- Immunity according to EN 61547
- Lifetime: up to 100,000 h
- Type of protection: IP20

## Product family datasheet

### Technical data

#### Electrical data

Product description	Efficiency in full-load	Networked standby power	Maximum output power
OTi DALI 15/220...240/1A0 NFC	88 % <sup>1)</sup>	≤ 0.27 W <sup>1)</sup>	18 W
OTi DALI 25/220...240/700 NFC	88 % <sup>1)</sup>	0.15 W <sup>1)</sup>	27 W
OTi DALI 35/220...240/1A0 NFC	90 % <sup>1)</sup>	0.15 W <sup>1)</sup>	35 W
OTi DALI 50/220...240/1A4 NFC	91 % <sup>1)</sup>	< 0.15 W <sup>1)</sup>	55 W

<sup>1)</sup> at 230 V, 50 Hz

#### Dimensions & weight

Product description	Product weight	Cable cross-section, input side	Cable cross-section, output side	Wire preparation length, input side	Wire preparation length, output side
OTi DALI 15/220...240/1A0 NFC	100.00 g	0.2...1.5 mm <sup>2</sup> <sup>1)</sup>	0.2...1.5 mm <sup>2</sup> <sup>1)</sup>	8.0...9.0 mm	8.0...9.0 mm
OTi DALI 25/220...240/700 NFC	145.00 g	0.2...1.5 mm <sup>2</sup> <sup>1)</sup>	0.2...1.5 mm <sup>2</sup> <sup>1)</sup>	8.0...9.0 mm	8.0...9.0 mm
OTi DALI 35/220...240/1A0 NFC	145.00 g	0.2...1.5 mm <sup>2</sup> <sup>1)</sup>	0.2...1.5 mm <sup>2</sup> <sup>1)</sup>	8.0...9.0 mm	8.0...9.0 mm
OTi DALI 50/220...240/1A4 NFC	175.00 g	0.2...1.5 mm <sup>2</sup> <sup>1)</sup>	0.2...1.5 mm <sup>2</sup> <sup>1)</sup>	8.0...9.0 mm	8.0...9.0 mm

Product description	Height	Width	Length	Mounting hole spacing, length	Mounting hole spacing, width
OTi DALI 15/220...240/1A0 NFC	30.0 mm	53.0 mm	95.0 mm		
OTi DALI 25/220...240/700 NFC	29.5 mm	67.0 mm	103.0 mm	94.0 mm	58.0 mm
OTi DALI 35/220...240/1A0 NFC	29.5 mm	67.0 mm	103.0 mm	94.0 mm	58.0 mm
OTi DALI 50/220...240/1A4 NFC	25.0 mm	75.0 mm	110.0 mm	99.0 mm	64.0 mm

<sup>1)</sup> Solid or flexible leads

# Product family datasheet

## Product line drawing

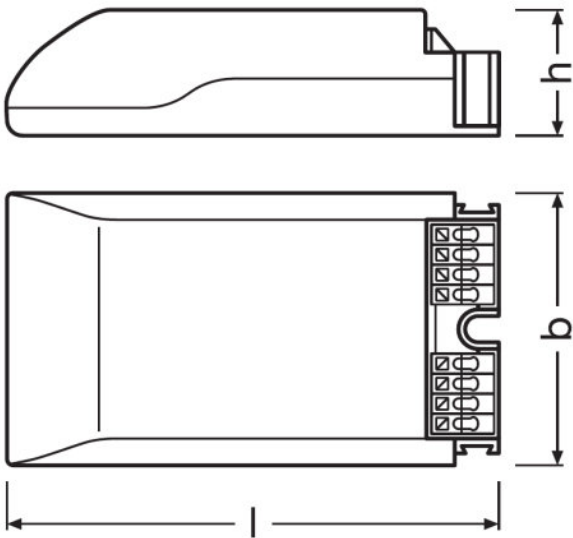

OTi DALI 15/220...240/1A0 NFC

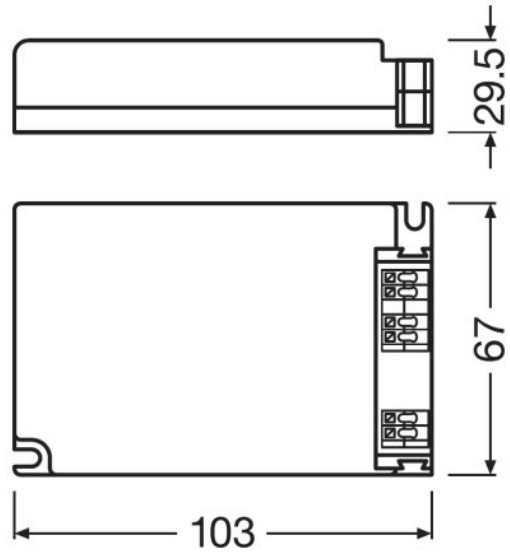

OTi DALI 25/220...240/700 NFC

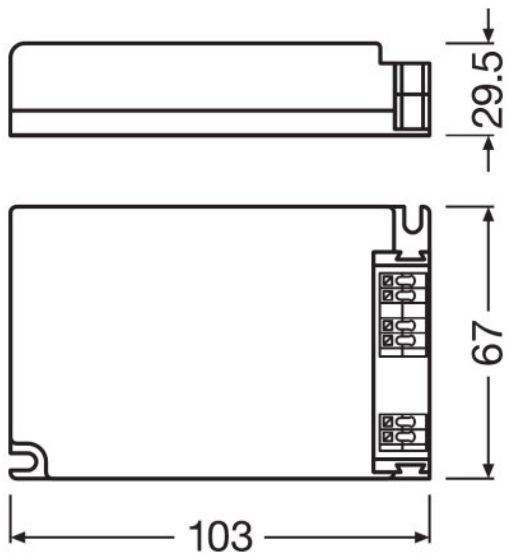

OTi DALI 35/220...240/1A0 NFC

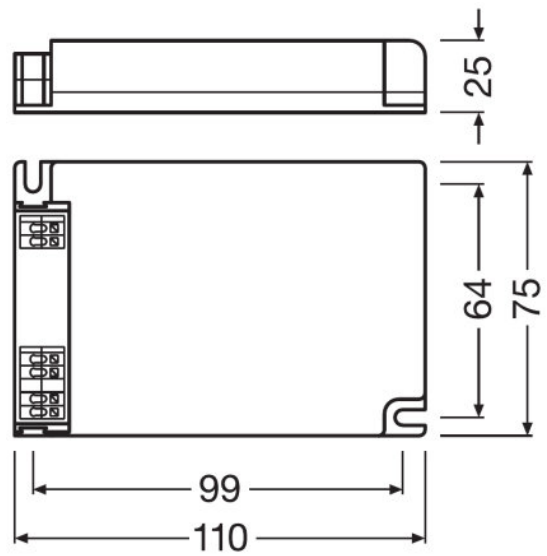

OTi DALI 50/220...240/1A4 NFC

## Product family datasheet

### Colors & materials

Product description	Casing material
OTi DALI 15/220...240/1A0 NFC	Plastic
OTi DALI 25/220...240/700 NFC	Plastic
OTi DALI 35/220...240/1A0 NFC	Plastic
OTi DALI 50/220...240/1A4 NFC	Plastic

### Temperatures & operating conditions

Product description	Ambient temperature range	Maximum temperature at tc test point	Max.housing temperature in case of fault	Temperature range at storage
OTi DALI 15/220...240/1A0 NFC	-20...+50 °C	80 °C <sup>1)</sup>	110 °C	-40...+85 °C
OTi DALI 25/220...240/700 NFC	-20...+50 °C	75 °C <sup>1)</sup>	110 °C	-40...+85 °C
OTi DALI 35/220...240/1A0 NFC	-20...+50 °C	80 °C <sup>1)</sup>	110 °C	-40...+85 °C
OTi DALI 50/220...240/1A4 NFC	-20...+50 °C	80 °C <sup>1)</sup>	110 °C	-40...+85 °C

Product description	Permitted rel. humidity during operation
OTi DALI 15/220...240/1A0 NFC	5...85 % <sup>2)</sup>
OTi DALI 25/220...240/700 NFC	5...85 % <sup>2)</sup>
OTi DALI 35/220...240/1A0 NFC	5...85 % <sup>2)</sup>
OTi DALI 50/220...240/1A4 NFC	5...85 % <sup>2)</sup>

<sup>1)</sup> Maximum at the T<sub>c</sub>-point

<sup>2)</sup> Maximum 56 days/year at 85 %

### Lifespan

Product description	ECG lifetime
OTi DALI 15/220...240/1A0 NFC	50000 / 100000 h <sup>1)</sup>
OTi DALI 25/220...240/700 NFC	50000 / 100000 h <sup>2)</sup>
OTi DALI 35/220...240/1A0 NFC	50000 / 100000 h <sup>2)</sup>
OTi DALI 50/220...240/1A4 NFC	50000 / 100000 h <sup>1)</sup>

<sup>1)</sup> T<sub>c</sub> = 80°C, 0.2% / 1,000 h failure rate / T<sub>c</sub> = 70°C, 0.1% / 1,000 h failure rate

<sup>2)</sup> T<sub>c</sub> = 75°C, 0.2% / 1,000 h failure rate / T<sub>c</sub> = 65°C, 0.1% / 1,000 h failure rate

### Capabilities

Product description	Intended for no-load operation
OTi DALI 15/220...240/1A0 NFC	No
OTi DALI 25/220...240/700 NFC	No
OTi DALI 35/220...240/1A0 NFC	No
OTi DALI 50/220...240/1A4 NFC	No

## Product family datasheet

### Programming

Product description	Programming device	Tuner4TRONIC Field App	Tuner4TRONIC
OTi DALI 15/220...240/1A0 NFC	DALI / NFC	Yes	Yes
OTi DALI 25/220...240/700 NFC	DALI / NFC	Yes	Yes
OTi DALI 35/220...240/1A0 NFC	DALI / NFC	Yes	Yes
OTi DALI 50/220...240/1A4 NFC	DALI / NFC	Yes	Yes

Product description	Box programming
OTi DALI 15/220...240/1A0 NFC	
OTi DALI 25/220...240/700 NFC	Yes
OTi DALI 35/220...240/1A0 NFC	Yes
OTi DALI 50/220...240/1A4 NFC	Yes

### Programmable features

Product description	OEM Key	Configuration Lock	DALI-2 Luminaire Data
OTi DALI 15/220...240/1A0 NFC	No	Yes	Yes <sup>1)</sup>
OTi DALI 25/220...240/700 NFC	No	Yes	Yes <sup>1)</sup>
OTi DALI 35/220...240/1A0 NFC	No	Yes	Yes <sup>1)</sup>
OTi DALI 50/220...240/1A4 NFC	No	Yes	Yes <sup>1)</sup>

Product description	Emergency Mode	TouchDIM + Sensor	Dim to Dark
OTi DALI 15/220...240/1A0 NFC	Yes	Yes	Yes
OTi DALI 25/220...240/700 NFC	Yes	Yes	Yes
OTi DALI 35/220...240/1A0 NFC	Yes	Yes	Yes
OTi DALI 50/220...240/1A4 NFC	Yes	Yes	Yes

Product description	Soft Switch Off	Driver Guard	DALI Settings
OTi DALI 15/220...240/1A0 NFC	Yes	Yes	Yes
OTi DALI 25/220...240/700 NFC	Yes	Yes	Yes
OTi DALI 35/220...240/1A0 NFC	Yes	Yes	Yes
OTi DALI 50/220...240/1A4 NFC	Yes	Yes	Yes

Product description	Constant Lumen	Lamp Operating Time	Corridor Functionality
OTi DALI 15/220...240/1A0 NFC	Yes	Yes	
OTi DALI 25/220...240/700 NFC	Yes	Yes	
OTi DALI 35/220...240/1A0 NFC	Yes	Yes	Yes
OTi DALI 50/220...240/1A4 NFC	Yes	Yes	

<sup>1)</sup> Acc. DALI part 251

## Product family datasheet

### Certificates & standards

Product description	Approval marks – approval	Standards	Protection class	Type of protection
OTi DALI 15/220...240/1A0 NFC	CE / EL / ENEC 10 / VDE-EMC / DALI-2	Acc. to EN 61347-1/Acc. to EN 61347-2-13/Acc. to EN 55015/Acc. to EN 61547/Acc. to EN 61000-3-2/Acc. to EN 62384/Acc. to EN 62386/Acc. to IEC 62386-101:Ed2/Acc. to IEC 62386-102:Ed2/Acc. to IEC 62386-207:Ed1	II	IP20
OTi DALI 25/220...240/700 NFC	CE / EL / ENEC 10 / VDE / VDE-EMC / DALI-2 / EAC / MM	Acc. to EN 61347-1/Acc. to EN 61347-2-13/Acc. to EN 55015/Acc. to EN 61547/Acc. to EN 61000-3-2/Acc. to EN 62384/Acc. to EN 62386/Acc. to IEC 62386-101:Ed2/Acc. to IEC 62386-102:Ed2/Acc. to IEC 62386-207:Ed1	II	IP20
OTi DALI 35/220...240/1A0 NFC	CE / EL / ENEC 10 / VDE / VDE-EMC / DALI-2 / EAC / MM	Acc. to EN 61347-1/Acc. to EN 61347-2-13/Acc. to EN 55015/Acc. to EN 61547/Acc. to EN 61000-3-2/Acc. to EN 62384/Acc. to EN 62386/Acc. to IEC 62386-101:Ed2/Acc. to IEC 62386-102:Ed2/Acc. to IEC 62386-207:Ed1	II	IP20
OTi DALI 50/220...240/1A4 NFC	CE / EL / DALI-2 / EAC	Acc. to EN 61347-1/Acc. to EN 61347-2-13/Acc. to EN 55015/Acc. to EN 61547/Acc. to EN 61000-3-2/Acc. to EN 62384/Acc. to EN 62386/Acc. to IEC 62386-101:Ed2/Acc. to IEC 62386-102:Ed2/Acc. to IEC 62386-207:Ed1	II	IP20

### Logistical data

Product description	Commodity code
OTi DALI 15/220...240/1A0 NFC	850440829000
OTi DALI 25/220...240/700 NFC	850440829000
OTi DALI 35/220...240/1A0 NFC	850440829000
OTi DALI 50/220...240/1A4 NFC	850440829000

## Product family datasheet

















### Application advice

For more detailed application information and graphics please see product datasheet.

### Sales and Technical Support

Sales and Technical Support [www.osram.com](http://www.osram.com)

### Download Data

File	
	User instruction OPTOTRONIC LED Power Supply
	User instruction OPTOTRONIC LED Power Supply
	Certificates OT EMC 40050085 200220
	Certificates OTI DALI 15 NFC EATON AM35709 210720
	Certificates OTI DALI 15 NFC INOTEC AM35709 210720
	Certificates OT ENEC 40038447 210721
	Certificates OT EMC 40044675 250621
	Declarations of conformity OTI DALI NFC UK DoC 4291512 240221
	Declarations of conformity OTI DALI NFC CE 3758701 200821
	CAD data OTI DALI 15 NFC IGS 170120
	CAD data OTI DALI 15 NFC STEP 170120
	CAD Data 2-dim OTI DALI 15 NFC CAD2PDF 170120
	CAD data 3-dim OTI DALI 15 NFC CAD3PDF 170120
	User instruction OPTOTRONIC LED Power Supply
	User instruction OPTOTRONIC LED Power Supply
	Certificates OTI DALI 25 NFC INOTEC 080121



## Product family datasheet

	Certificates OTI DX DALI NFC CB DE1 63108 190220
	Certificates OTI DALI 25 NFC EATON 080121 (EN)
	Declarations of conformity OTI DX DALI NFC CE 3770568 210921
	Declarations of conformity OTI DALI DX NFC UK CE 4281072 210121
	CAD data OTI DALI 25 35 NFC IGS 280120
	CAD data OTI DALI 25 35 NFC STEP 280120
	CAD Data 2-dim OTI DALI 25 35 NFC CAD2PDF 280120
	CAD data 3-dim OTI DALI 25 35 NFC CAD3PDF 280120
	Certificates OTi DALI 35 1A0 NFC EAT AM22187 090120
	Certificates OTi DALI 35 1A0 NFC INO AM22187 090120
	Certificates OTI DALI 35 NFC INOTEC 080121
	Certificates OTI DALI 35 NFC EATON 080121
	User instruction OPTOTRONIC LED Power Supply
	Certificates OTI DALI 50 NFC INOTEC 080121
	Certificates OTI DALI 50 NFC EATON 080121
	CAD data CAD data OTi DALI 50220-2401A4 NFC built in IGS
	CAD data CAD data OTi DALI 50220-2401A4 NFC built in STEP
	CAD data PDF CAD data OTi DALI 50220-2401A4 NFC built in pdf

## Product family datasheet

### Ecodesign regulation information:

Intended for use with LED modules.

The forward voltage of the LED light source shall be within the defined operating window of the control gear in all operating conditions including dimming if applicable.

Separate control gear and light sources must be disposed of at certified disposal companies in accordance with Directive 2012/19/EU (WEEE) in the EU and with Waste Electrical and Electronic Equipment (WEEE) Regulations 2013 in the UK. For this purpose, collection points for recycling centres and take-back systems (CRSO) are available from retailers or private disposal companies, which accept separate control gear and light sources free of charge. In this way, raw materials are conserved and materials are recycled.

### Logistical Data

Product code	Product description	Packaging unit (Pieces/Unit)	Dimensions (length x width x height)	Volume	Gross weight
4062172061766	OTi DALI 15/220...240/1A0 NFC	Shipping carton box 20	284 mm x 207 mm x 96 mm	5.64 dm <sup>3</sup>	2270.00 g
4062172017909	OTi DALI 25/220...240/700 NFC	Shipping carton box 20	218 mm x 158 mm x 155 mm	5.34 dm <sup>3</sup>	3037.00 g
4062172017923	OTi DALI 35/220...240/1A0 NFC	Shipping carton box 20	218 mm x 158 mm x 155 mm	5.34 dm <sup>3</sup>	3037.00 g
4062172061889	OTi DALI 50/220...240/1A4 NFC	Shipping carton box 20	262 mm x 253 mm x 98 mm	6.50 dm <sup>3</sup>	3754.00 g

The mentioned product code describes the smallest quantity unit which can be ordered. One shipping unit can contain one or more single products. When placing an order, for the quantity please enter single or multiples of a shipping unit.

### Accessories Optional

Product description	Accessory name	Accessory code
OTi DALI 15/220...240/1A0 NFC	OT CABLE CLAMP F-STYLE	▶ 4052899325555
OTi DALI 25/220...240/700 NFC	OT CABLE CLAMP B-STYLE	▶ 4052899077881
OTi DALI 25/220...240/700 NFC	OT CABLE CLAMP B-STYLE TL	▶ 4052899948051
OTi DALI 35/220...240/1A0 NFC	OT CABLE CLAMP B-STYLE	▶ 4052899077881
OTi DALI 35/220...240/1A0 NFC	OT CABLE CLAMP B-STYLE TL	▶ 4052899948051
OTi DALI 50/220...240/1A4 NFC	OT CABLE CLAMP A-STYLE	▶ 4052899089570
OTi DALI 50/220...240/1A4 NFC	OT CABLE CLAMP A-STYLE TL	▶ 4052899325982

### Data privacy

## Product family datasheet

This OSRAM driver can be configured using the Tuner4TRONIC software. This requires registering on [www.myosram.com](http://www.myosram.com) and downloading the Tuner4TRONIC software from the Internet. The Tuner4TRONIC software enables users to access and view the operational data of a luminaire or driver via the corresponding programming interfaces. A password key (Config Lock) must be set up in the driver via the Tuner4TRONIC software in order to control which users can access and view operational data. Follow the instructions for password setup. To grant an external person or company rights to access or view operational data, you can assign password keys. In this case, however, you are responsible for ensuring that the third party concerned takes notice of the information described here. However, OSRAM can read out operating data from devices for maintenance and service purposes even when a password key has been assigned. In individual cases, OSRAM will also use its access rights in order to optimize or improve driver hardware and driver functions. In accordance with data privacy principles, any user of operating data (luminaire manufacturers, third parties with access rights) must ensure that personal data (e.g. name, address, location IDs) are only merged with the prior written consent of the person (end user) concerned. The respective user of the operating data is responsible for providing evidence of consent.

---

### Disclaimer

Subject to change without notice. Errors and omission excepted. Always make sure to use the most recent release.